



www.meitrack.com



MEITRACK GROUP

Telematics & IOT Leading Provider

April 2024

Since 2002

Content

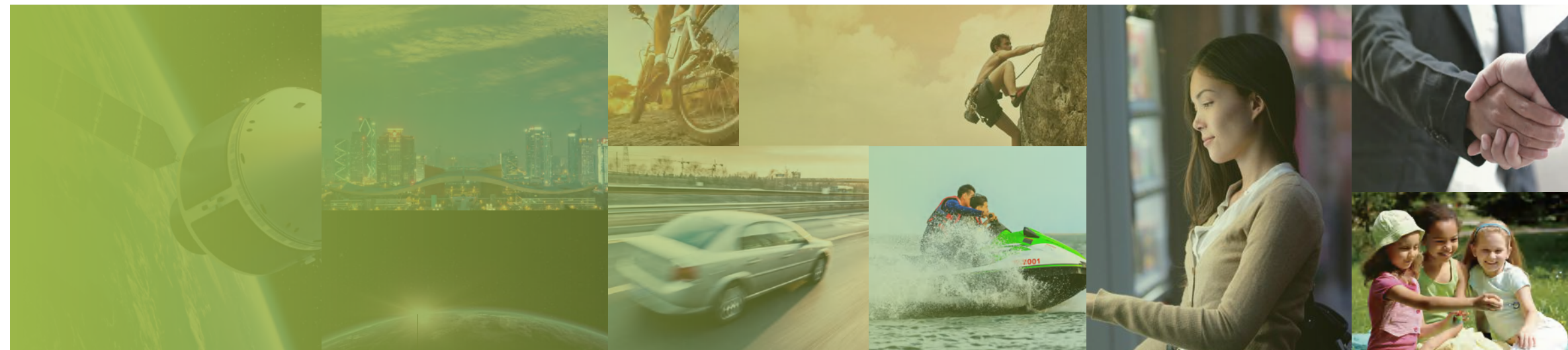

Company Overview 01-06

Milestones
Global Network
Strategic Cooperation

Manufacturing
Quality Management

Personal Tracker
Asset Tracker
Vehicle Tracker

Mobile DVR
Dashcam
GPS Tracking Platform

Product Portfolio 07-28

Fleet Management Solution 30-35

Vehicle Video Surveillance System
ADAS and DMS Systems
Upgraded Passenger Counting System

Tire Pressure Monitoring System
Fuel Monitoring System

Case Study 36-43

Contact Us 44



Company Overview

Since 2002.

20,000m² state of the art manufacturing facility based in Shenzhen, China.

Placed in-house R&D centers in Taiwan, Shenzhen and the United States.

Providing OEM&ODM service.

Providing software development service.

Global network covering Europe, USA, CIS, Middle East, and Asia Pacific Region.



Milestones

- 2022 ● Launched its first AI MDVR, and the capability of telematics integration was greatly improved.
- 2020 ● Meitrack Japan branch was established.
- 2018 ● Releasing in-house developed MDVR solutions.
- 2017 ● Developed its first vehicle tracker running on 4G network.
- 2017 ● Launched tracking devices compatible with LTE Cat-M network.
- 2013 ● Meitrack Taiwan branch and its R&D center were established.
- 2010 ● Began to develop IoT technology, Meitrack as its own brand was brought to market.
- 2009 ● Meitrack USA branch was established.
- 2007 ● Meitrack HK branch and Dongguan Factory were established.
- 2005 ● Developed its first in-house personal GPS tracker GT30i.
- 2002 ● Founded in Shenzhen, China with the registered capital of CNY20 million.

Global Network



5 branch offices **80%** products exported to more than **170** countries and regions worldwide

Strategic Cooperation



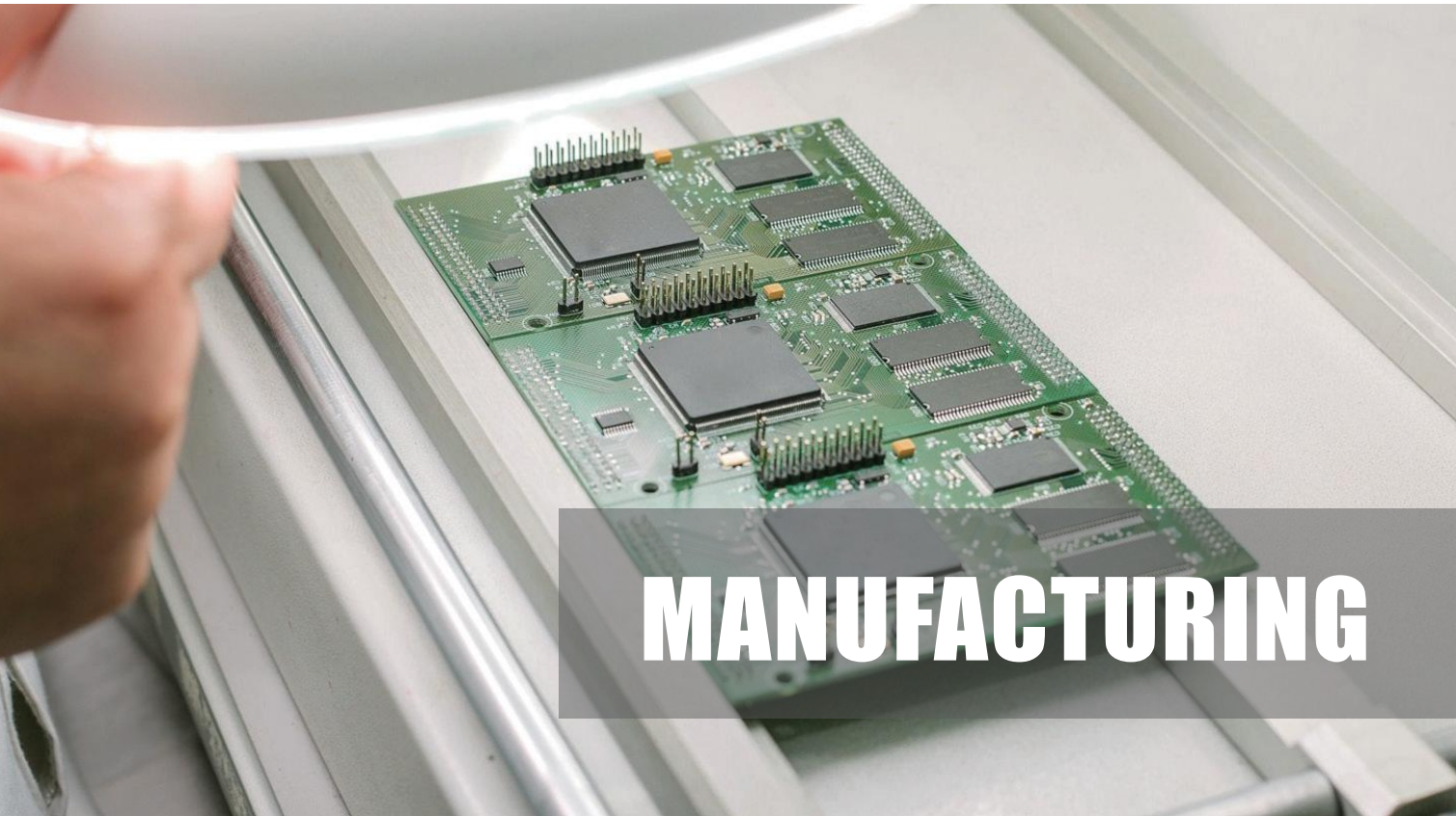

MANUFACTURING

Standardized Production Management

GPS signal generators MP9000 & MP9100 Agilent GSM/GPRS integrated tester 8960 Reflow soldering, SMT machine, solder paste printer, AOI tester...

Strict Quality Control

IATF16949:2016 Quality Management System ISO9001:2015 Quality Management System Certs: CE, FCC, RoHS, PAHs, etc.

State of the Art Equipment

All painted anti-static production floor Air shower room ensuring dust-free workshop Aging treatment on all products...

Quality Management



IQC

- Inspect all accessories and main materials to ensure zero defects.
- Adopt United States defense standard MIL-STD-105E (II).



SMT QC

- Reflow soldering with 8 high temperature zones.
- Multi-functional SMT machine (JUKI); support minimum size: 0201.
- AOI inspection after reflow soldering.



DIP QC

- Inspect pseudo soldering and non-soldering.
- First article inspection.



Aging Inspection

- All products are passed 36 hours' 60°C aging inspection.
- High temperature aging treatment room.



GPS Tracker QC

- QC of semi-finished products.
- Test the working mode of semi-finished products, such as the call and vibration functions.
- Simulate the base station to send GSM signals to ensure positioning accuracy and data consistency.



Packing QC

- IPQC inspectors monitor the whole production process.
- OQC inspectors randomly inspect products.
- Rework unqualified products.

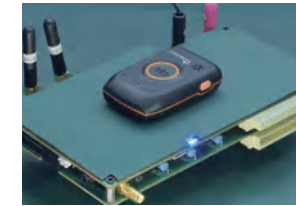

Finished Goods Inspection

- Test product performance.
- Inspect product appearances.
- Make records.



OQC

- Label raw materials.
- Use the high-end electrical testing record system (MyCom) to inspect products.
- Adopt comprehensive ERP system to ensure high-efficiency management.

GPS Tracking Products: Personal Trackers



P88L

- Battery capacity: 1000mAh
- Standby time up to 200h
- SOS button, man-down alert, two-way calling, fast magnetic charging, wireless charging

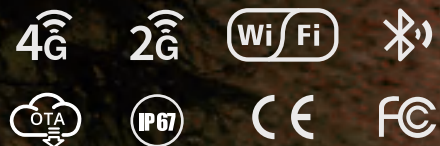

P99L

- Battery capacity: 2000mAh
- Standby time up to 400h
- Shock-resistant construction
- SOS button, man-down alert, two-way calling, fast magnetic charging, wireless charging



GPS Tracking Products: Asset Trackers



TA255 series

- Solar charging
- Battery capacity up to 22,400mAh
- Magnetic mounting
- I/O cable version optional

4G 2G Wi-Fi Bluetooth
 CE ISO 7637

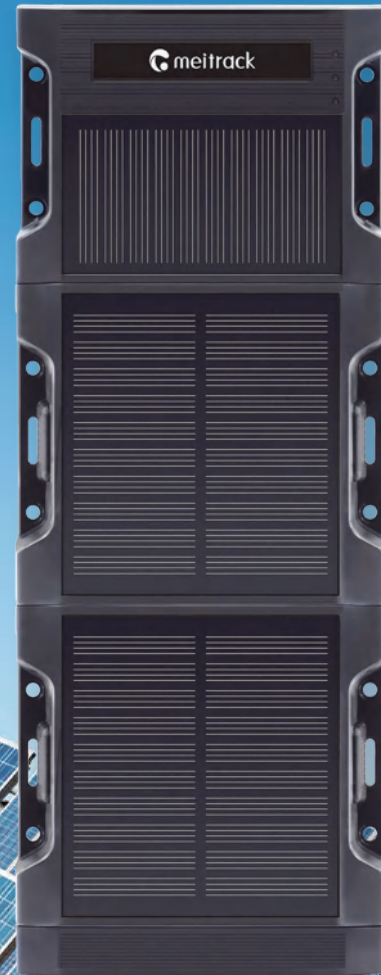

K211L

- Turn on / lock the gate with RFID or the platform
- Lock rope length: 300 mm (customizable)
- 78-Day battery life
- Shock-resistant construction

4G 2G OTA IP67 CE



GPS Tracking Products: Vehicle Trackers



TC68L

- Plug and Play design with an OBD II plug
- OBD: read OEM parameters such as mileage, RPM, fuel level, providing real-time data
- In-vehicle WiFi hotspot (2.4 GHz)
- Disconnect alert

4G 2G Wi-Fi FOTA CE



TS299L

- Plug and Play design with a cigarette lighter receptacle
- In-vehicle WiFi hotspot (2.4 GHz)
- Disconnect alert

4G 2G Wi-Fi FOTA CE



T711L

- Compact size; competitive price (L*W*H=75*44*17mm)
- Full IP67 immobilizer with an IP67-rated relay (optional)
- Driving behavior analysis
- Driver identification

4G 2G * FOTA CE CITC



T399 series

- Full IP67 immobilizer with an IP67-rated relay (optional)
- Driving behavior analysis
- Configurable I/O ports
- RS232 or CAN bus

4G 2G * FOTA CE



T333L

- Tire pressure monitoring
- Remote vehicle immobilization
- Driving behavior analysis
- Two-way communication
- RS232



T633L

- L1+L5 dual-band signals & dead reckoning
- High-precision impact/rollover detection
- Configurable I/O ports
- RS232, RS485, CAN bus

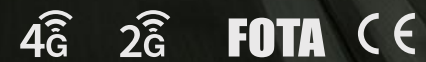

T622 series

- Iridium SBD airtime service
- T622G-F9 is certified by Iridium
- RS232 & CAN bus



Livestreaming MDVRs: State-of-the-art MDVR systems equipped with livestreaming capabilities for real-time monitoring and surveillance.

MDVRs with AI Algorithm (ADAS, DMS, BSD): Intelligent MDVR solutions integrated with AI algorithms including Advanced Driver Assistance Systems (ADAS), Driver Monitoring Systems (DMS), and Blind Spot Detection (BSD) for enhanced safety and efficiency.

High-definition dashcam offering superior video quality and seamless recording functionalities for comprehensive vehicle surveillance

Video Telematics



MD101



2 Cameras

- ADAS, DMS (auto calibration)
- AI self-learning keeps improving the algorithm
- Remote video & audio surveillance
- Support CMSV6 & MS03
- Dual IP: watch videos on two platforms synchronously
- Harsh braking & acceleration detection
- Storage capacity: up to 256GB
- Protocols: JT/T 1078-2016, JT/T808-2019



DLT

MD600



6 Cameras

- ADAS & DMS
- Blind spot detection
- Passenger flow monitoring
- Storage: a 2TB M.2 SSD and two 512GB SD cards
- Dual IP: watch videos on two platforms synchronously
- Compatible with CVBS and VGA displays
- Built-in 6-axis acceleration sensor
- Flexible I/O ports
- RS232, RS485 & CAN Bus



FOTA

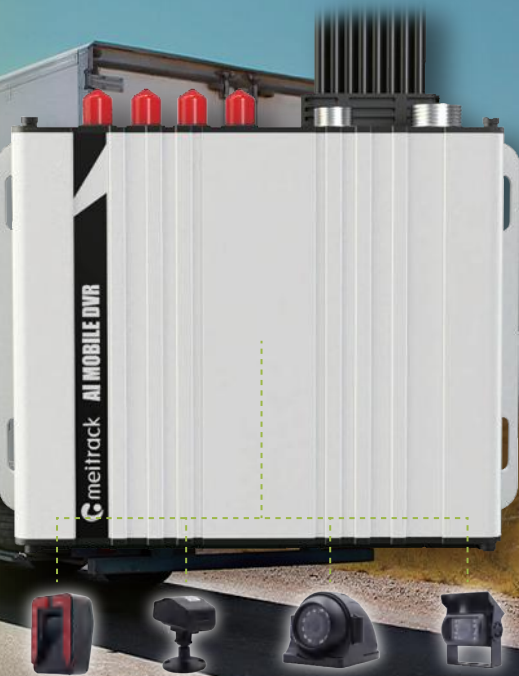

MD833H



- ADAS & DMS
- Blind spot detection
- Storage: a 2TB HDD/SSD and a 512GB SD card
- Dual IP: watch videos on two platforms synchronously
- Remote video & audio surveillance
- Compatible with CVBS and VGA displays
- RS232, RS485 & CAN Bus

4G 2G Wi Fi Bluetooth FOTA CE



MD500S



- ADAS & DMS
- Passenger flow monitoring
- Remote video & audio surveillance
- Storage capacity: up to 256GB
- Dual IP: watch videos on two platforms synchronously
- RS232 & CAN bus

4G 2G Wi Fi Bluetooth FOTA CE



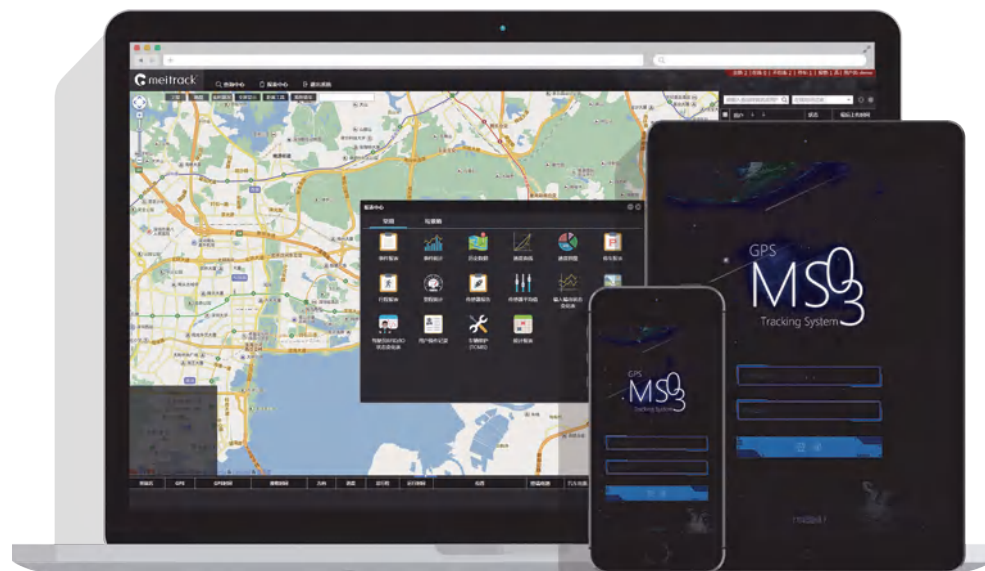

GPS Tracking & Video Surveillance Platform

MS03

MS03 is the newest GPS tracking innovation from Meitrack Group. Extensive programming combined with an esthetically designed user interface (UI), giving the MS03 platform a much more user friendly experience. The platform consists of an extendable database, which ultimately can meet various functional requirements and needs.

<https://www.trackingmate.com>

Contact us to get a free demo!

-  300+ Functions Customizable
-  Native APP with MDVR Online
-  Multiple Polygon Geo-fences
-  Off-route Alert
-  Reverse Geocoding
-  All-in-one Platform
-  Multi-screen Monitoring
-  Multi-lingual
-  White Label
-  Economical

Fleet Management Solution



Vehicle Video Surveillance System

Adopting the high-performance processor and Linux operating system, Meitrack independently develops a new-generation wireless vehicle video surveillance system that uses H.265 video compression/ decompression, GPS positioning and wireless data transmission technologies. It is specially designed for mobile video surveillance for different types of vehicles, such as buses, long-distance coaches, taxis, logistics vehicles, armored cars, private cars, etc.



ADAS and DMS Systems

The ADAS and DMS Systems are developed to enhance vehicle safety and improve better driving. ADAS, are systems that help avoid collisions and other accidents by offering technologies that alert the driver to potential risks. DMS system can identify driver's abnormal behaviours such as fatigue driving, distracted driving, smoking etc.. It can also verify the driver's identity via the face recognition algorithm. These greatly reduce driving accidents and save lives.

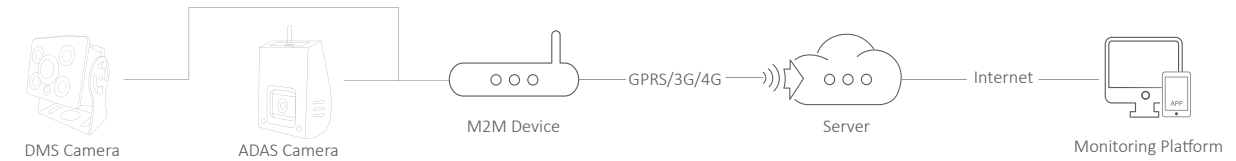



Upgraded Passenger Counting System

Meitrack independently develops a passenger counting system to count the number of passengers that get on and get off buses. Under standard environments, the system can reach a high rate of accuracy. More importantly, managers can get counting reports from Meitrack MS03 tracking platform. This is an effective way to determine passenger load for the purpose of adjusting driving routes and operating time to prevent overloading of the vehicles, and thus reduce operating costs.

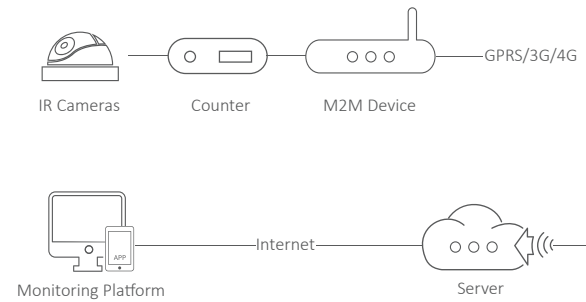

Tire Pressure Monitoring System

Vehicle's tires play an important role in every vehicle out on the road. Having a tire pressure monitoring system installed may ensure that you are always driving with a safe set of tires on the road. It is a great option for long distance travel that can be installed into all major vehicles models including trucks, private cars, buses, freight trailers, etc.

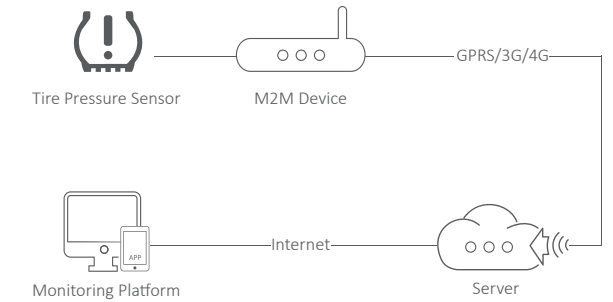



Fuel Monitoring System

Meitrack vehicle trackers are compatible with major fuel level sensors in the industry, including the resistive fuel level sensor, CLS sensor, LLS sensor, and ultrasonic fuel level sensor. After a tracker is connected to the fuel monitoring system, besides basic location information, customers can also get fuel consumption, fuel level, fuel leak, fuel theft information, etc. More importantly, managers can get fuel reports from Meitrack MS03 tracking platform, which helps fleet companies understand where improvements and adjustments are needed.

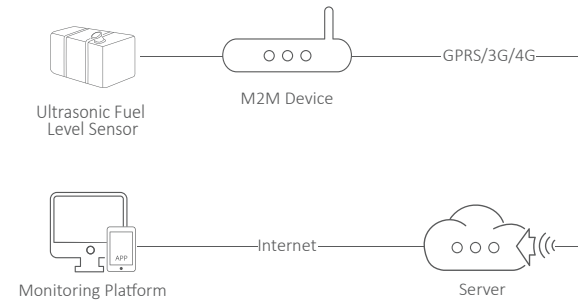

Case Study



Water Sport

P99L | Australia

The P99L features water resistance ratings, long battery life, and is one of the ideal choices for water sports. It can pinpoint real-time locations of outdoor enthusiasts and provide reassurance for participants.

In addition, the tracking unit can keep a comprehensive log of their sporting performances that can be later viewed from Meitrack MS03 tracking system on a computer or smartphone.



Law Enforcement Agency

P88L | China

With the implementation of the Meitrack's GPS Tracking System, police officers are provided with an opportunity to be monitored for quality and safety measures that will position them to complete their duties adequately. With access to SOS, speakers, and high-power microphone, law enforcement will be equipped with high-quality technology to make their jobs not only more seamless but safer as well without interference.

This new instrument also allows the vital function of data transmission with a high confidentiality level. Within this realm of technology, the device is unable to perform if lost or stolen. With no way of being hacked, it protects the positioning and identity of our police officers and presents the opportunity for continued success.



Taxi Management

T333 | Thailand

The Thailand government applied Meitrack's GPS tracking solution in order to enhance the safety of drivers and passengers while improving the taxi service. Taxis are equipped with the T333 tracker, magnetic card reader, taximeter, and camera. These taxis can only be driven by authorized drivers. In case of emergency, the government monitoring center can pinpoint the location quickly and efficiently, and take immediate action.



City Buses

MD522S | Mexico

The Mexican government introduced Meitrack's MDVR bus management solution to guarantee the safety of Mexican residents, ensure a safe bus travel, and prevent illegal activities inside buses. In this project, Meitrack MD522S, camera, LCD display, SOS button, A91 passenger flow sensor and MS03 tracking platform work together to provide a one-stop internal bus monitoring solution.



Palm Garden

Lora-based tracking solution | Malaysia

This project is applicable to large orchards, palm plantations, and farms where are usually far away from the city center. Due to a lack of GSM network coverage, after transportation vehicles enter these areas, they cannot be monitored, tracked, and managed in real time. Therefore, we develop a vehicle tracking management device based on LoRa and 3G dual communication to help farm managers resolve data communication problems in areas without GSM network coverage.



Fruit Delivery

K211G | Thailand

Farmers in Thailand are using 500 sets Meitrack's GPS fleet tracking system to help track fresh organic fruits from farm-to-table to guarantee the authenticity and security of transportation. During fresh produce transportation, Meitrack K211G GPS smart locks, T399G vehicle trackers, temperature sensors, and the web-based or app-based MS03 platform work together to provide one-stop delivery services for the farms.

Armored Vehicles

MD511H | Malaysia

Inside an armored bank vehicle, a MD511H mobile DVR is connected to four cameras. The video surveillance solution only allows authorized staff to start the vehicle. If the vehicle door is opened without permission or the vehicle is hijacked, the monitoring center can quickly and efficiently keep track of what's happening inside the vehicle, remotely cut off the engine to prevent the vehicle from moving, and take immediate action to minimize the loss.



Meitrack Group

Tel: +86 (755) 8346 2818
 Fax: +86 (755) 2383 2013
 Email: info@meitrack.com
 Web: www.meitrack.com
 Address: 5/F, International Internet Finance Pioneer Park, No. 1, Taohua Rd., Futian Free Trade Zone, Shenzhen, China. 518038

Meitrack USA

Tel: +1 (877) 559 1755
 Fax: +1 (888) 501 2168
 Address: 3191 W Temple Ave Ste 230 Pomona, CA 91768

Meitrack Japan

Tel: +81 (50) 5806-0998
 Address: Shinagawa Grand Central Tower, 2-16-4 Konan, Minato-ku, Tokyo 108-0075 Japan

Joyntech (Shenzhen)

Tel: +86 (755) 8346 2818
 Fax: +86 (755) 2383 2013
 Address: 5/F, International Internet Finance Pioneer Park, No. 1, Taohua Rd., Futian Free Trade Zone, Shenzhen, China. 518038

Meitrack Taiwan

Tel: +886 (2) 2659 2199
 Fax: +886 (2) 2659 2197
 Address: 8F, No. 74, Zhouzi ST., Neihu DIST., Taipei City 11493, Taiwan (R.O.C.)

Meitrack Hong Kong

Tel: +852 2152 1733
 Fax: +852 3579 0638
 Address: ROOM 702, 7/F, SPA CENTRE, NO.53-55 LOCKHART ROAD, WAN CHAI, HK

Meitrack Group Longhua Factory

Tel: +86 (755) 8171 2818
 Fax: +86 (755) 2919 5855
 Address: Meicheng Industrial Park, Dalang, Longhua Shenzhen China. 518109

